

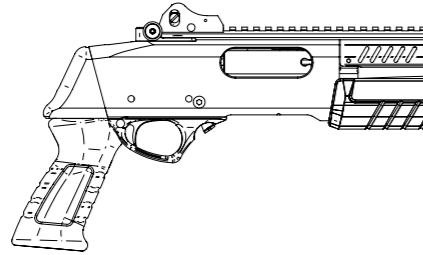

FABARM
PROFESSIONAL

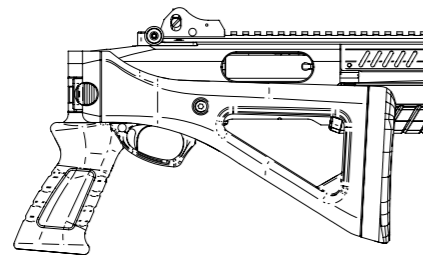

STF/12

SHORT

STF/12

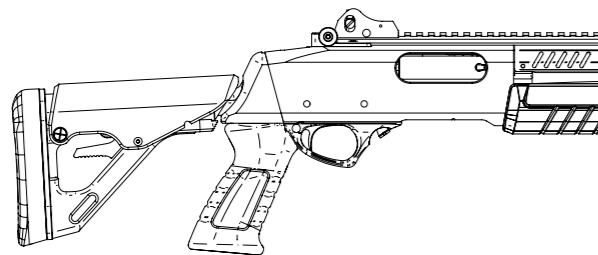
COMPACT

STF/12

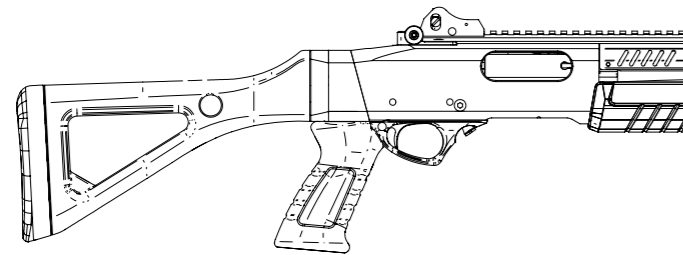
TELESCOPIC

STF/12

PISTOLGRIP

THE DESIGN OF THE STF/12 IS BASED ON THE INTERCHANGEABILITY OF DIFFERENT MODULES TO CREATE AN INTEGRATED PUMP SHOTGUN, PERFECT IN ALL CIRCUMSTANCES FOR ALL TYPES OF MISSIONS.

STF/12

This platform allows the rapid change of barrels, magazine capacity, sights and all accessories. It also allows with the use of a barrel with a length of only 11 inches, to have an extremely handy, compact and efficient weapon. The FABARM PROFESSIONAL division created in 2015 proposed to revolutionize the approach of the last decades regarding pump-action shotguns. The STF/12 imposes itself year after year as the shotgun with the highest quality criteria, criteria focused not on the cost of production but only on the level of performance, on the resistance and even more on the precision. The general design of the weapon is part of this dynamic: The weapon is linear, fluid, racy, with ergonomics designed for the most demanding operators looking for the pump shotgun of the 21st century!

Lo studio del STF/12 nasce dall'idea di intercambiabilità fra i vari elementi, con l'obiettivo di ottenere un fucile a pompa interamente modulabile, perfetto in ogni circostanza ed adatto a tutti i tipi d'impiego. Questa piattaforma consente un rapido cambio delle canne, della capacità del serbatoio, delle mire e di tutti gli accessori. Permette inoltre con l'utilizzo di una canna della lunghezza di soli 11 pollici, di avere un'arma estremamente maneggevole, compatta e performante. La divisione FABARM PROFESSIONAL creata nel 2015 si proponeva di rivoluzionare l'approccio degli ultimi decenni per quanto riguarda i fucili a pompa. L'STF/12 si impone anno dopo anno come il fucile con i più alti criteri qualitativi, criteri focalizzati non sul costo di produzione ma solo sul livello delle prestazioni, sulla resistenza e ancor più sulla precisione. Il design generale dell'arma fa parte di questa dinamica: l'arma è lineare, fluida, accattivante, con un'ergonomia pensata per gli operatori più esigenti alla ricerca del fucile a pompa del 21° secolo!

La concezione del STF/12 repose sur l'interchangeabilité de différents éléments afin de créer un fusil à pompe entièrement modulaire, parfait en toutes circonstances pour tous types de missions. Cette plateforme permet le changement rapide des canons, de la capacité de magasin, des organes de visées et de tous les accessoires. Elle permet aussi avec l'utilisation d'un canon d'une longueur de 11 pouces seulement, d'avoir une arme extrêmement maniable, compacte et performante. La division FABARM PROFESSIONAL créée en 2015 proposait de révolutionner l'approche des dernières décennies quant aux fusils à pompe. Le STF/12 s'impose année après année comme le fusil à pompe ayant les plus hauts critères de qualité, critères focalisés non pas sur le coût de production mais uniquement sur le niveau de performance, sur la résistance et plus encore sur la précision. Le design général de l'arme s'inscrit dans cette dynamique : L'arme est linéaire, fluide, racée, avec une ergonomie pensée pour les opérateurs les plus exigeants recherchant le fusil à pompe du XXI siècle !



FABARM
PROFESSIONAL

**MODULAR, ACCURATE
POWERFUL AND READY
FOR ANY USE!**

5

MODULARE, PRECISO, POTENTE E
PRONTO PER OGNI UTILIZZO!
MODULAIRE, PRÉCIS, PUISSANT ET
ADAPTÉ À TOUTES LES SITUATIONS !

STF/12

INDEX INDICE
SOMMAIRE

- 1. INTRODUCTION
- 3. INDEX
- 4. DEEP DRILLING TECHNOLOGY
- 5. QUALITY MANUFACTURED
- 6. MODULAR BARRELS
- 7. THE SMOOTHEST PUMPING SHOTGUN
- 7. SOFT TOUCH COATING
- 8. HIGHLY ADAPTABLE
- 10. FLAT SIGHTING SYSTEM
- 11. QUICK RELEASE PIVOT RAIL
- 11. LATERAL MIL-STD 1913 RAIL
- 12. SLING ATTACHMENT POINTS
- 14. ADVANCED MUZZLE BREAK
- 15. MEDIUM CONTOUR BARREL
- 16. INCREDIBLE LONG RANGE PRECISION
- 18. OBSTRUCTED BORE TEST
- 19. A MECHANISM DESIGN FOCUSED ON SAFETY
- 20. THE INDIVIDUAL C.I.P. PROOFING
- 22. EXCLUSIVE 1630 BAR TEST
- 23. FIRING TEST
- 24. STF/12 COMPACT
- 30. STF/12 SHORT
- 36. STF/12 TELESCOPIC
- 42. STF/12 PISTOLGRIP
- 49. ACCESSORIES
- 56. OVERALL LENGTH IN CM

100% MADE IN ITALY

DEEP DRILLING TECHNOLOGY

EN All STF/12 barrels are produced with deep drilling technology out of solid steel bars of chrome molybdenum. This technology allows the molecular structure of the steel to remain intact during the manufacturing of the barrels. The barrels, thus having none of the tension inevitably generated by the process of cold forging, remain perfectly rectilinear during the phase of silver soldering the components of the barrel at temperatures of over 700 degrees. The advantage of this production process explains why there is today no pump shotgun with a such extreme accuracy level.

IT Tutte le canne STF/12 sono forate dal pieno, da barre d'acciaio al cromo molibdeno. Questa tecnologia permette di mantenere intatta la struttura molecolare dell'acciaio durante la fabbricazione dei tubi. I tubi non hanno quindi l'inevitabile tensione generata dal processo di martellatura a freddo, restando perfettamente rettilinei durante la fase di saldatura all'argento dei componenti della canna a oltre 700 gradi. I vantaggi di questo processo di produzione spiegano le ragioni per cui ad oggi nessun fucile a pompa offre un tale livello di precisione.

FORATURA DELLE CANNE FORAGE DES CANONS



FR Tous les canons STF/12 sont produits par forage hors masse de barres d'acier au chrome molybdène. Cette technologie permet de maintenir intacte la structure moléculaire de l'acier pendant la fabrication des tubes. Les tubes n'ayant ainsi pas les tensions inévitablement générées par le procédé de martelage à froid, ils restent parfaitement rectilignes durant la phase de soudure à l'argent des composants du canon à plus de 700 degrés. Les avantages de ce processus de production expliquent les raisons pour lesquelles il n'y a à ce jour aucun fusil à pompe avec un tel niveau de précision.

QUALITY MANUFACTURED

LIVELLO SUPERIORE DI QUALITÀ HAUT NIVEAU DE QUALITÉ

EN The premium 7075 T6 aluminium alloy used for the STF/12 frame achieves all crucial factors focused on high strength/weight ratio, high stress resistance and great machinability. The monolithic frame has been shaped for optimizing rigidity and endurance. The hard anodizing treatment prevents all risks of corrosion but generates also an excellent correlation between the tensile strength, the hardness and wear resistance.

IT La lega di alluminio 7075 T6 utilizzata per la carcassa STF/12 soddisfa i criteri più importanti incentrati su un elevato rapporto resistenza/peso, un'elevata resistenza alle sollecitazioni meccaniche ed una grande lavorabilità. La carcassa monolitica è stata studiata per ottimizzare rigidità e durabilità. Il trattamento di ossidazione anodica dura previene ogni rischio di corrosione ma genera anche un'ottima correlazione tra la resistenza alla trazione, la durezza e la resistenza all'usura.

FR L'alliage d'aluminium 7075 T6 utilisé pour la carcasse STF/12 remplit tous les critères clefs que sont parfait rapport résistance/poids, résistance élevée aux contraintes mécaniques et bonne usinabilité. La carcasse monolithique a été développée pour optimiser la rigidité et durabilité. Le traitement par anodisation dure évite tout risque de corrosion mais génère également une excellente corrélation entre la résistance à la traction, la dureté et la résistance à l'usure.

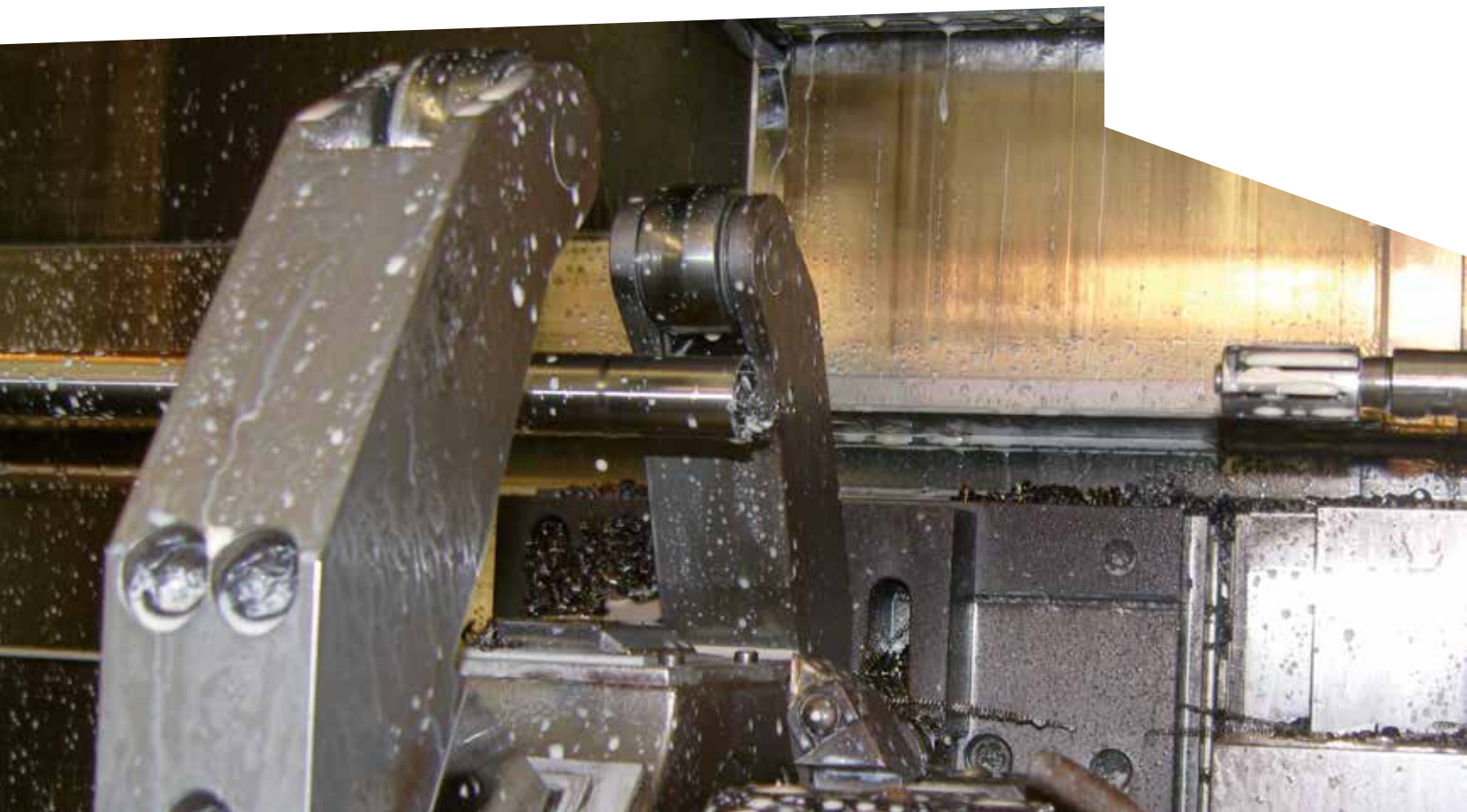
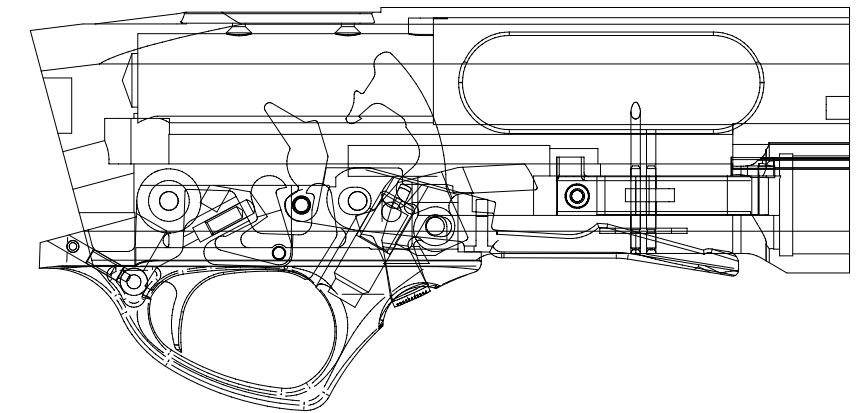

MODULAR BARRELS

CANNE INTERCAMBIABILI
CANONS INTERCHANGEABLES

Interchangeable barrels lengths:

11" | 14" | 18" | 20" | 22"

3-inch chamber
Hard chrome plated bore

Canne intercambiabili, differenti lunghezze:

11" | 14" | 18" | 20" | 22"

Camera 12-3" (12/76 mm)
Anima canna interamente cromata

Différentes longueurs de canons interchangeables:

11" | 14" | 18" | 20" | 22"

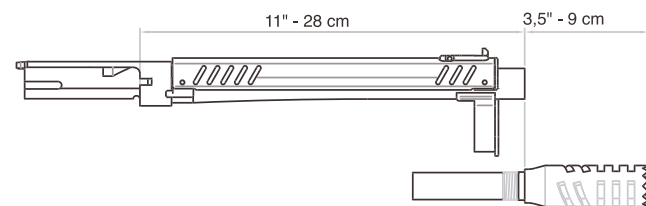
Chambre 12-3" (12/76 mm)
Ame de canon entièrement chromée

878 gr.

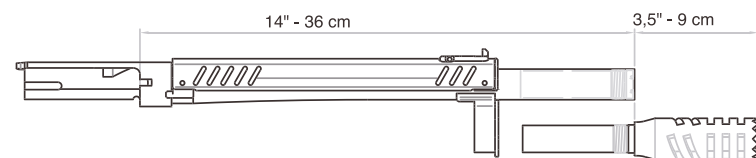

956 gr.

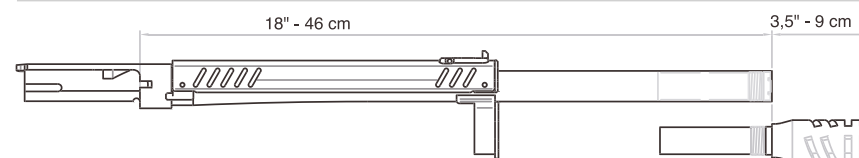

1.053 gr.

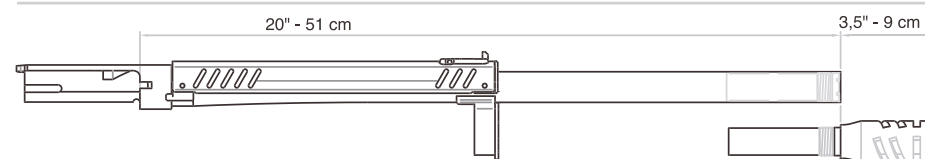

1.087 gr.

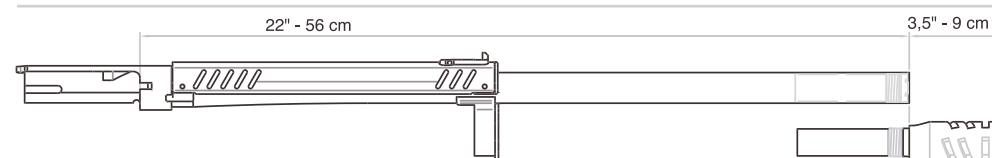

1.144 gr.

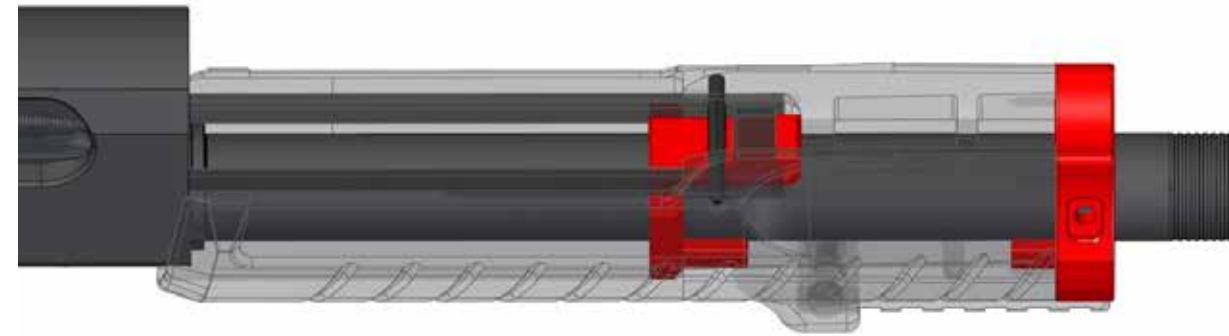
THE SMOOTHEST
PUMPING SHOTGUNMOVIMENTO A POMPA
ESTREMAMENTE FLUIDO
MOUVEMENT A POMPE
EXTREMEMENT FLUIDE

EN Fast and precise cycling pump action with ERGAL 55 (aircraft-grade Aluminum alloy 7075) inserts inside the forend. These two hard-anodized inserts are milled from solid block with precision surface to ensure smooth functions and proper alignment pump action on the magazine tube.

IT Con gli inserti nell'astina in ERGAL 55 (lega di alluminio aeronautico 7075) il ciclo di riarmo è rapido e preciso. Questi due inserti sono ottenuti da un blocco di alluminio e trattati con ossidazione anodica dura per garantire un azionamento fluido ed un perfetto allineamento sul tubo serbatoio.

FR Rapide et précis réarmement à pompe grâce à des inserts en ERGAL 55 (Alliage aéronautique d'aluminium 7075) dans le garde-main. Ces deux inserts traités par anodisation dure sont fraisés hors-masse avec une qualité de surface parfaite pour garantir un coulisement fluide et un alignement précis sur le tube magasin.

SOFT TOUCH
COATINGTRATTAMENTO SOFT TOUCH
SOFT TOUCH TREATMENT

EN SOFT TOUCH is a unique stock and forend treatment to improve the grip in all weather conditions (rain, cold temperature ...). Once treated, a composite material feels almost velvety smooth and soft as a rubber coating. This coating also makes the composite less noisy, in addition to being extremely durable.

IT Il SOFT TOUCH è un trattamento unico per il calcio e l'asta per aumentare la presa in tutte le condizioni atmosferiche (pioggia, freddo ...). In seguito al trattamento il materiale composito risulta vellutato e morbido al tatto come fosse ricoperto di gomma. Oltre ad essere estremamente resistente questo trattamento rende anche il composito meno rumoroso.

FR SOFT TOUCH est un revêtement spécifique appliqué sur la crosse et le garde-main afin d'améliorer le grip et la prise en main, y compris sous la pluie ou par très basses températures. Ainsi traitée, la matière composita prend un toucher caoutchouteux. Ce traitement rend aussi le composite très silencieux et est un revêtement très résistant.



STF/12

SHORT

EN The STF/12 SHORT is assembled with a composite grip, perfect when engagement ranges are short.

IT Il fucile SFT/12 SHORT è dotato di impugnatura in materiale composito, perfetto quando le distanze di ingaggio sono ravvicinate.

FR Le STF/12 SHORT possède une poignée en composite, parfait quand l'espace d'intervention est réduit.



STF/12

COMPACT

EN The STF/12 COMPACT is using a polymer side-folding stock which make it readily adaptable at the operator level to a multitude of missions.

IT Il fucile SFT/12 COMPACT è dotato di un calcio pieghevole lateralmente che lo rende rapidamente adattabile alle necessità dell'operatore in una moltitudine di impieghi.

FR Le STF/12 COMPACT comporte une crosse pliable latéralement qui le rend aisément adaptable aux souhaits de l'opérateur pour une multitude de missions.



EN STF/12 can still be fired from the folded position. The folded stock maintains a perfect access to trigger, safety button, forend for a cycling pump action and magazine tube to load the shotgun.

IT Con il fucile STF/12 è possibile sparare anche con il calcio piegato. Il calcio anche se chiuso garantisce un accesso completo al grilletto, alla sicura, all'astina e al serbatoio per le operazioni di riarmo e di caricamento.

FR STF/12 peut faire feu en position pliée. La crosse rabattue maintient un parfait accès à la détente, au poussoir sécurité, au garde-main pour réarmer l'arme et au tube magasin pour charger le fusil.

STF/12

TELESCOPIC



EN The STF/12 TELESCOPIC is using a collapsible stock with 6 optional length positions and an adjustable cheek rest. Its length-of-pull dimensions from mm. 250 to mm. 360 (9,84" to 14,17") give the opportunity to find the optimum adjustment for the use. Made from polymer composite and Aluminum 7075 it is precise, ambidextrous and integrates a sling swivel connector. Available in black or flat earth colours.

IT L'STF/12 TELESCOPIC ha un calcio retraibile su 6 diverse posizioni di lunghezza e un nasello regolabile. La lunghezza del calcio può variare da 250 mm a 360 mm (9,84" a 14,17") permette la configurazione ottimale all'uso. Costruito in polimero di composito e in Ergal 55, è preciso, ambidestro e prevede un punto di fissaggio per le cinghie. Disponibile nei colori nero o Flat Earth.

FR Le STF/12 TELESCOPIC possède une crosse rétractable qui comporte une longueur réglable à 6 différentes positions ainsi qu'un busc ajustable. La longueur de crosse pouvant varier de 250 mm à 360 mm (9,84" à 14,17"), elle donne l'opportunité d'une configuration optimale adaptée à l'usage. Réalisée en polymère de composito et en aluminium 7075, elle est précise, ambidextre et comporte un point de fixation pour les bretelles. Disponible en couleurs noire ou Flat Earth.

EN The TELESCOPIC stock features an adjustable cheek rest with 5 drop positions that remains in place independent from the length-of-pull position. A "one-hand" button allows to instantly adjust its drop for using ideally the STF/12 with all types and sizes of scopes.

IT Il calcio telescopico prevede un nasello, regolabile su 5 posizioni di altezza, che rimane nella configurazione selezionata indipendentemente dalla lunghezza scelta per il calcio. Un bottone azionabile con una sola mano permette di regolare velocemente la sua piega per un utilizzo perfetto dell'STF/12 con tutti i tipi e dimensioni di ottica.

FR La crosse Télescopique possède un busc réglable avec 5 positions de hauteur, lequel reste en place indépendamment de la longueur de crosse choisie. Un bouton actionnable avec une seule main permet de régler instantanément sa pente pour utiliser idéalement l'STF/12 avec tous les types et toutes les tailles de lunettes de tir.



STF/12

PISTOLGRIP



EN The STF/12 PISTOLGRIP is featured a premium ergonomic fixed stock with textured gripping surfaces and a parallel comb to keep the shotgun on the target when firing.

IT STF/12 PISTOLGRIP è fornito di un calcio fisso ergonomico con superfici grappanti ed una impostazione per ridurre il rilevamento durante il tiro.

FR Le STF/12 PISTOLGRIP possède une crosse fixe très ergonomique qui a des zones rugueuses pour une parfaite prise en main et un busc dont la pente, parallèle au canon, réduit le relèvement du fusil lors de tirs.



**QUICK-RELEASE
PIVOT RAIL**

SLITTA AMOVIBILE CON PIVOT
RAIL DEMONTABLE A PIVOT



EN The STF/12 is equipped with a long mm.390 free floating and removable MIL-STD 1913 rail at the 12 o'clock position. The ghost sight and front sight, studied for elevation and deviation corrections, can be instantly detached from the rail.

IT Il fucile STF/12 è dotato di una slitta MIL-STD 1913 flottante e rimovibile. La tacca di mira ed il mirino, sviluppati per consentire regolazioni in altezza e deviazione, possono essere rimossi istantaneamente dalla slitta.

FR Le STF/12 est équipé sur sa partie supérieure d'un long rail Picatinny flottant et détachable de 390 mm, rail au standard MIL-STD 1913. La dioptre et le guidon, développés pour pouvoir ajuster la hauteur et le déport latéral peuvent être instantanément retirés du rail.

**FLAT SIGHTING
SYSTEM**

SISTEMA DI MIRE BASSE
SYSTEME DE VISEE BASSE

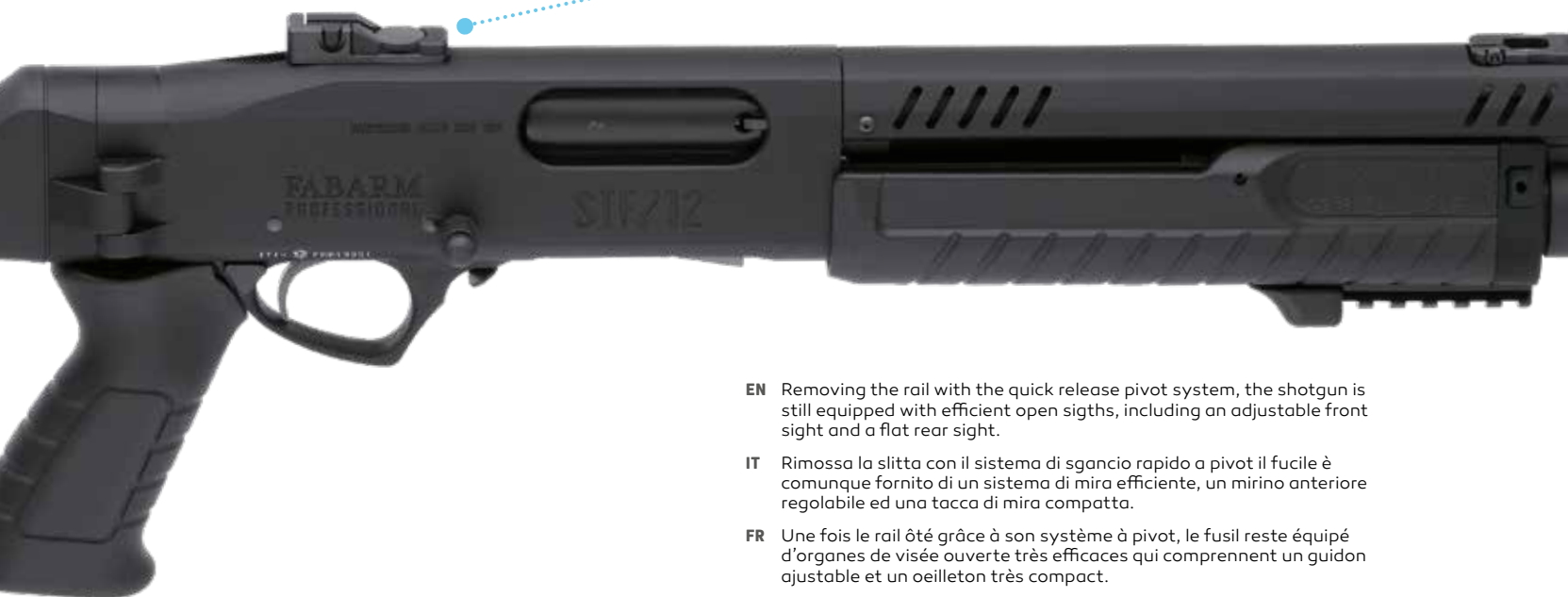

EN Removing the rail with the quick release pivot system, the shotgun is still equipped with efficient open sights, including an adjustable front sight and a flat rear sight.

IT Rimossa la slitta con il sistema di sgancio rapido a pivot il fucile è comunque fornito di un sistema di mira efficiente, un mirino anteriore regolabile ed una tacca di mira compatta.

FR Une fois le rail ôté grâce à son système à pivot, le fusil reste équipé d'organes de visée ouverte très efficaces qui comprennent un guidon ajustable et un oeilleton très compact.

**LATERAL MIL-STD
1913 RAIL**

SLITTA LATERALE MIL-STD 1913
RAIL LATERAL MIL-STD 1913

EN An optional MIL-STD 1913 rail at 3 or 9 o'clock on which to mount optics or accessories.

IT Una slitta MIL-STD 1913 in opzione a ora 3 o ora 9 per montare ottiche o accessori.

FR Un rail MIL-STD 1913 en option pour fixer à 3 heures ou 9 heures optiques ou accessoires.



Product No: B-149-A

SLING ATTACHMENT POINTS

ANELLI PORTACINGHIA
ANNEAUX PORTE-BRETELLE



EN On STF/12 the sling mounts can be easily customized by the user to find the best one for its shotgun and use. It offers a variety of mounting options and locations for slings, to attach properly a 1-point, 2-points or 3-points sling.

IT Su STF/12 i anelli portacinghia possono essere facilmente personalizzati dal utente per trovare quello migliore per il proprio fucile e utilizzo. Offre una varietà di opzioni e di posizioni, per utilizzare correttamente tutte le cinghie a 1 punto, 2 punti o 3 punti.

FR Sur l'STF/12, les anneaux porte-bretelle peuvent être facilement personnalisés par l'opérateur pour finaliser le meilleur choix sur son propre fusil et en fonction de son utilisation. Il offre une variété d'options de montage et d'emplacements, afin de parfaitement utiliser les bretelles dites à 1 point, 2 points ou 3 points.



ADVANCED MUZZLE BREAK

FRENO DI BOCCA PERFORMANTE
FREIN DE BOUCHE PERFORMANT



EN The muzzle break reduces the recoil by redirecting the escape path of powder gas to three directions perpendicular to the STF/12 barrel. It allows the shooter to maintain an accurate site picture between shots.

IT Il muzzle break riduce il rinculo distribuendo la fuoriuscita dei gas della combustione in 3 direzioni perpendicolari. Garantisce al tiratore la possibilità di mantenere una posizione di tiro stabile.

FR Le frein de bouche réduit le recul en redirigeant la sortie des gaz de combustion vers 3 directions perpendiculaires à l'axe du canon. Il permet au tireur de garder une position stable entre les tirs.

MEDIUM CONTOUR BARREL

CANNA DAL DIAMETRO
ESTERNO MAGGIORATO
DIAMETRE EXTERIEUR
DE CANON MAJORE

EN The STF/12 features a distinctly medium contour barrel combined with a specific ACCURACY INNER HP choke tube. The results with slug ammunitions are just impressive!

IT STF/12 è dotato di una canna dal diametro esterno maggiorato fornita di un apposito strozzatore INNER HP ACCURACY. I risultati con le munizioni a palla sono semplicemente sorprendenti.

FR L' STF/12 possède un profil externe de canon au diamètre majoré lequel est associé à un choke spécifique INNER HP ACCURACY. Les résultats avec les munitions à balles sont tout simplement impressionnants!

VERTICAL DEFLECTION OF THE BARREL COMPARATIVE TEST

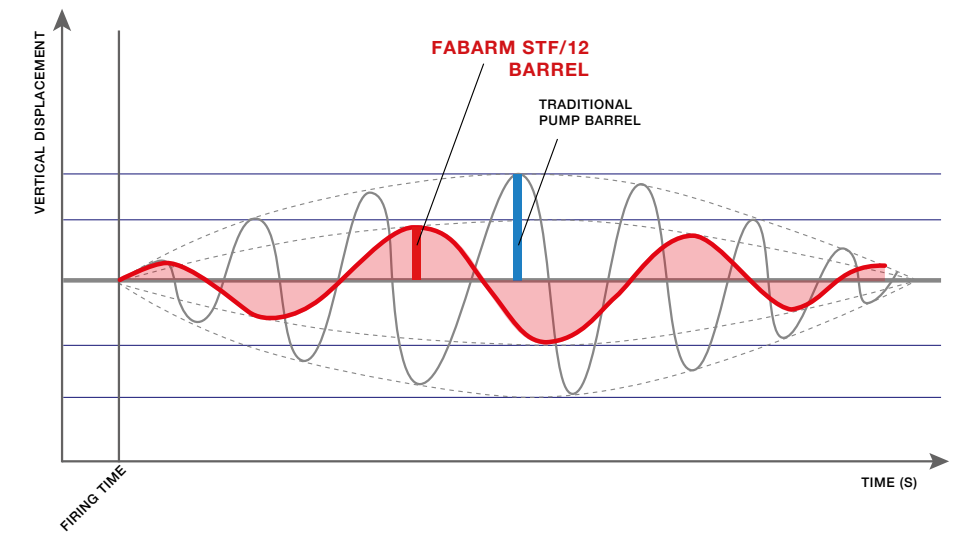

INCREDIBLE LONG RANGE PRECISION

PRECISIONE IMPRESSIONANTE SULLA LUNGA DISTANZA
UNE INCROYABLE PRECISION A LONGUE DISTANCE

EN The STF/12 barrel with its MEDIUM contour provides an incredible long-range precision. All these tests with scope have been made at the distance of 50 meters (54,70 yard) with the best premium slug ammunitions... reaching the impressive result of 3 impacts in less than a two inches group at 55 yard !

IT La canna dell'STF/12 cromata internamente e con profilo esterno maggiorato permette d'ottenere un'incredibile precisione sulle lunghe distanze. Tutti questi test sono stati effettuati alla distanza di 50 metri con ottica montata e con le migliori munizioni a palla...raggiungendo l'impressionante risultato di 3 impatti in meno di mm. 45 a 50 metri!

FR Le canon avec son âme chromée et son profil extérieur majoré permet d'obtenir une incroyable précision à longue distance. Tous ces tests, avec lunette de tir, ont été obtenus à la distance de 50 mètres (54,70 yard) avec les meilleures munitions à balles... atteignant l'impressionnant résultat de 3 impacts dans 45 mm à 50 mètres !

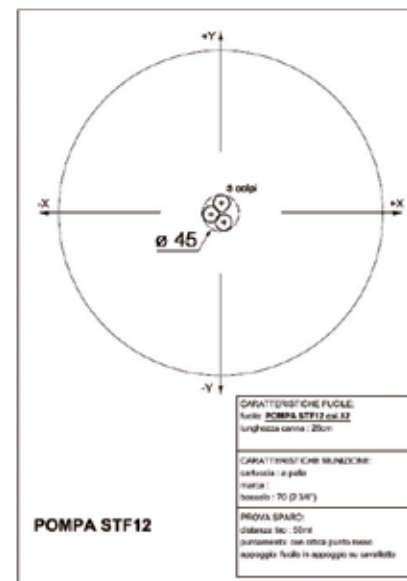
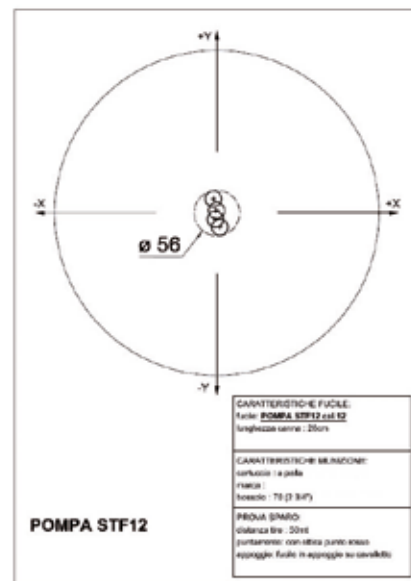
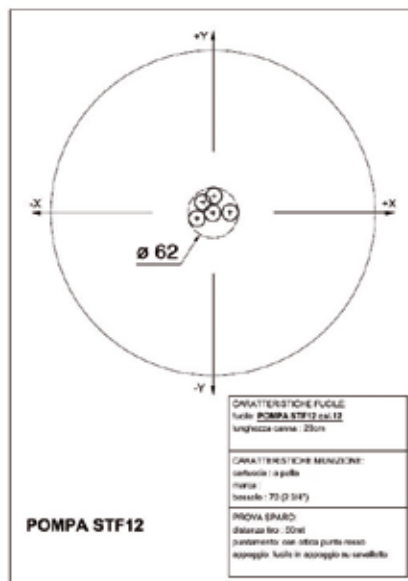
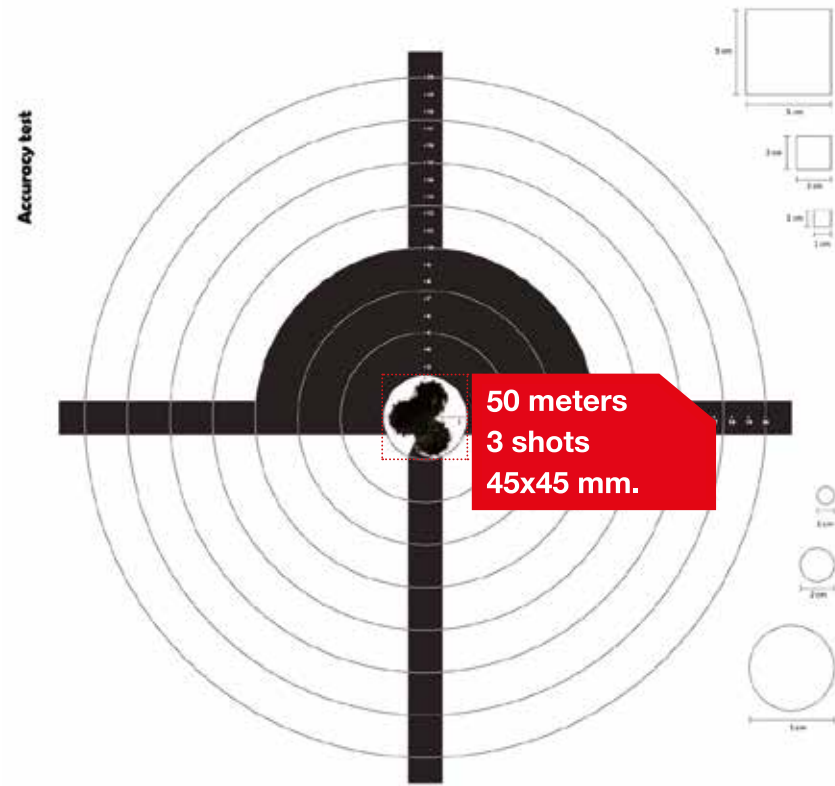

OBSTRUCTED BORE TEST

PROVA DELLA CANNA OSTRUITA
TEST DE CANON OBSTRUE

EN The objective of this test is to guarantee that if a projectile remains blocked in the barrel, the successive firing of a new round will not cause the barrel to break, thereby risking injury to the operator's hand (zone grip of the forend).

IT L'obiettivo di questa prova è garantire che, se un proiettile rimane bloccato nella canna, lo sparo successivo di una nuova cartuccia non provochi la rottura della canna, con il rischio di ferire la mano dell'operatore (zona di impugnatura dell'asta).

FR L'objectif de ce test est de garantir que si un projectile reste bloqué dans le canon, le tir successif d'une nouvelle cartouche n'engendrera pas la rupture du canon en risquant de ce fait, de blesser l'opérateur à la main (zone de préhension du garde-main).

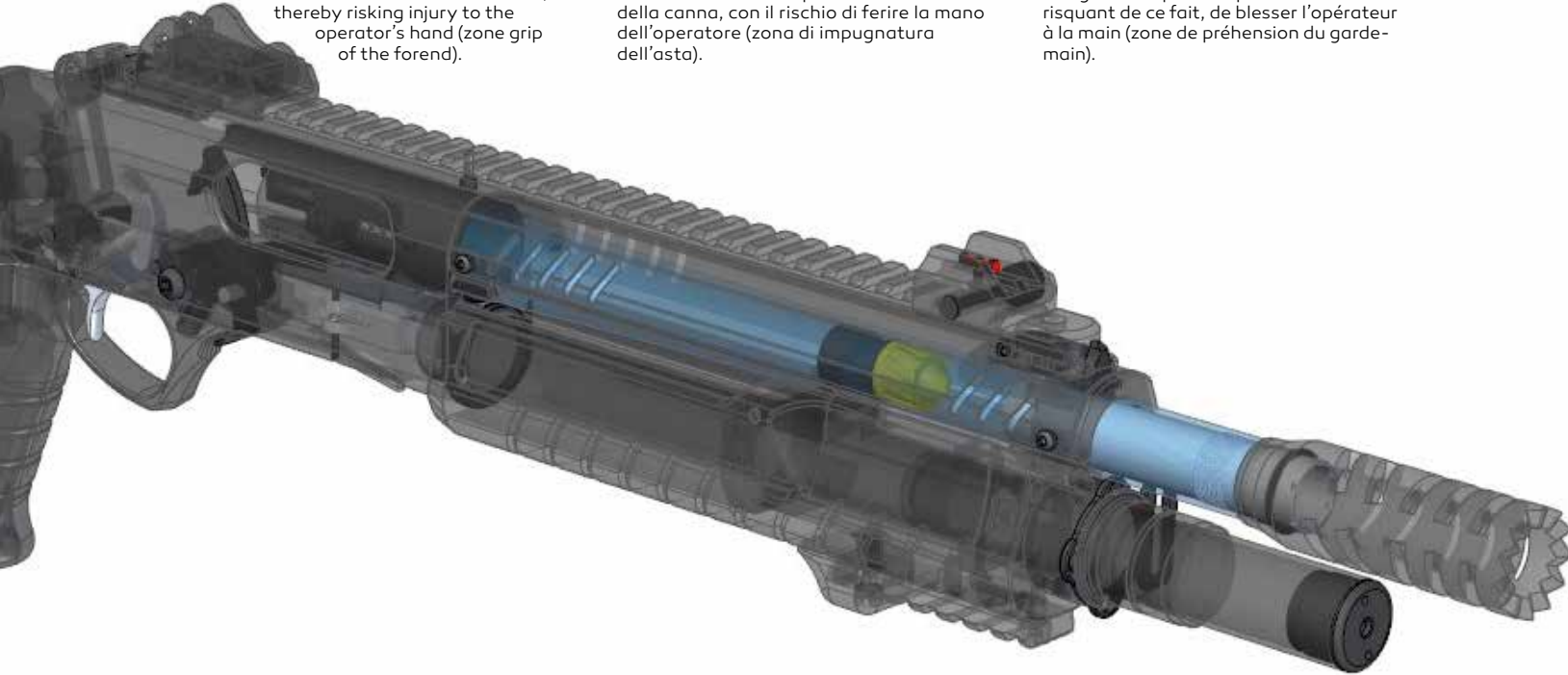

EN The test was carried out with a Brenneke cartridge, with the projectile stuck at a distance of 160 mm from the chamber rim. **RESULT:** The new round fired with the same ammunition type simply display a slight bulge in the barrel at the site of the original stuck bullet, but without tube blow up or ruptured. This means that there is no risk of hand injury to the operator!

IT Il test è stato condotto con munizione tipo Brenneke con proiettile immobilizzato all'interno della canna ad una distanza di 160 mm dal collarino della camera. **RISULTATO:** Lo sparo di una nuova cartuccia (dello stesso tipo) ha generato solo una deformazione del tubo canna dove era bloccato il proiettile, ma senza lacerazioni o rotture di quest'ultimo. Ciò significa che non vi è quindi alcun rischio di lesioni alla mano per l'operatore!

FR Le test a été conduit avec une munition de type Brenneke avec la balle immobilisée dans le canon à une distance de 160 mm du bourrelet de chambre. **RESULTAT :** Le tir d'une nouvelle cartouche (de même type) a uniquement généré une déformation du tube de canon à l'endroit où la balle était bloquée, mais sans déchirement et sans éclatement de ce dernier. Cela signifie qu'il n'y a donc pas de risque de blessure à la main pour l'opérateur!

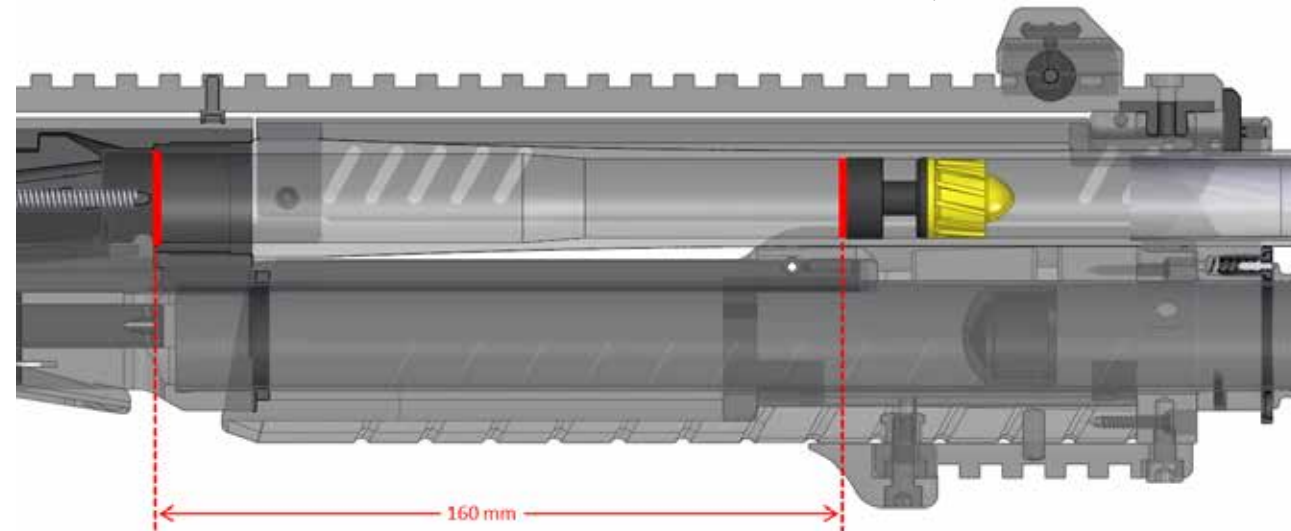

A MECHANISM DESIGN FOCUSED ON SAFETY

UN MECCANISMO PROGETTATO PER LA SICUREZZA
UN MECANISME DEVELOPPE POUR LA SURETE

21

EN The shotgun construction makes impossible any firing when the bolt is not perfectly closed. If the locking lug is not locked, the action bar stops the hammer which has no more the possibility to come on the firing pin.

IT Il meccanismo dell'arma rende impossibile lo sparo se l'otturatore non è in completa chiusura. Se l'arma non è chiusa, il cane viene intercettato dal carrello impedendo di fatto la percussione.

FR Le mécanisme de l'arme interdit toute percussion si la culasse n'est pas parfaitement fermée. Si le verrou n'est pas en position verrouillée, le bras de commande stoppe le mouvement du chien, lequel ne peut pas atteindre le percuteur.

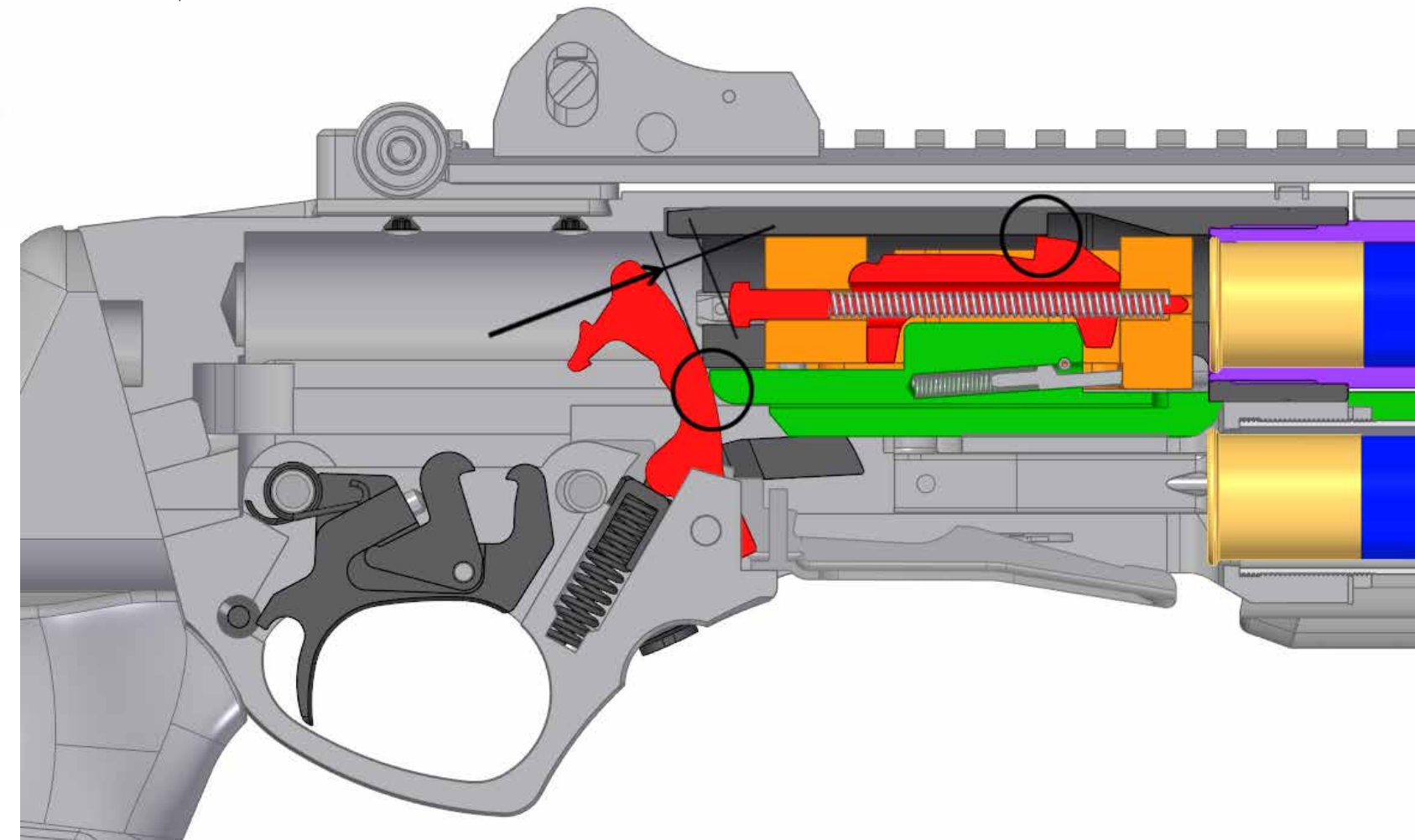

THE INDIVIDUAL C.I.P. PROOFING

LA PROVA INDIVIDUALE C.I.P.
L'ÉPREUVE INDIVIDUELLE C.I.P.

EN All STF/12 shotguns are individually proof tested following the C.I.P. (Permanent International Commission) standards. The proof consist of firing two overloaded 12/76 mm cartridges which develop a pressure corresponding at a pressure at least 25 % higher than the C.I.P maximum pressure of 1050 bar authorized for the cartridges loaded and manufactured in the commercial version. After these two shots, the National Italian Proof house is making a precise control of the firearm following the C.I.P. technical method. These controls combine measurements controls using various normalized gauges and visual controls. The positive proof test achieved, the specific proof marks are then applied on the STF/12 frame, bolt and barrel.

IT Tutti i fucili STF/12 sono testati singolarmente secondo il protocollo C.I.P. (Commissione Internazionale Permanente). Il test consiste nello sparo di due cartucce da 12/76 mm appositamente caricate per sviluppare una pressione di almeno il 25% superiore alla massima pressione C.I.P. di 1050 BAR autorizzata per le cartucce magnum prodotte e vendute sul mercato. Dopo questi due colpi, il Banco Nazionale di Prova Italiano procede ad un preciso controllo dell'arma secondo il protocollo previsto dalla C.I.P. Questa procedura prevede controlli dimensionali con diversi calibri normalizzati e controlli visivi. Terminata la prova con esito positivo, il Banco appone gli specifici punzoni sulla carcassa, la culatta e la canna dell'STF/12.

FR Tous les fusils STF/12 sont éprouvés individuellement selon le protocole de la C.I.P. (Commission internationale permanente). L'épreuve consiste à tirer deux cartouches 12/76 mm qui ont été spécifiquement encartouchées pour développer une pression supérieure d'au moins 25 % à la pression C.I.P. maximale autorisée de 1050 BAR des cartouches magnum manufacturées et commercialisées sur le marché. Après ces deux tirs, le Banc National d'épreuves Italien procède à un contrôle précis de l'arme à feu selon le protocole prévu par la C.I.P. Ces contrôles combinent des contrôles dimensionnels utilisant différents calibres normalisés et des contrôles visuels. Le test positif d'épreuve ainsi achevé, les poinçons spécifiques sont alors appliqués sur la carcasse, la culasse et le canon du STF/12.



EXCLUSIVE 1630 BAR TEST

PROVA ESCLUSIVA 1630 BAR
TEST EXCLUSIF 1630 BAR

EN FABARM company has established with the Italian National proof house of Gardone Val Trompia to submit the STF/12 shotgun to an additional overpressure test. While the C.I.P. high-pressure test in 12 gauge is carried out at 1320 BAR, the STF/12 shotguns are subsequently tested with one cartridge developing an overpressure of 1630 BAR. This proof-test successfully superseded, a specific 1630 BAR certificate is established and delivered with each STF/12. FABARM is the only manufacturer to have agreed to a such test protocol ; the clients' safety is an absolute priority !

IT La ditta FABARM ha stabilito con il Banco Nazionale di Prova di Gardone Val Trompia di sottoporre il fucile STF/12 ad un ulteriore test di sovrappressione. Mentre la prova C.I.P. di alta pressione in calibro 12 viene effettuata a 1320 BAR, i fucili STF/12 vengono ulteriormente testati con una cartuccia che sviluppa una sovrappressione di 1630 BAR. A prova superata con successo, viene emesso uno specifico certificato 1630 BAR fornito con ogni STF/12. FABARM è l'unico produttore ad aver definito un tale protocollo di prova; la sicurezza dei clienti è una priorità assoluta!

FR La société FABARM a établi avec le Banc d'Épreuves National Italien de Gardone Val Trompia de soumettre le fusil STF/12 à un test additionnel de surpression. Alors que pour la C.I.P. le test de haute pression en calibre 12 est effectué à 1320 BAR, les fusils STF/12 sont ultérieurement testés avec une cartouche développant une surpression de 1630 BAR. Ce test passé avec succès, un certificat 1630 BAR spécifique est établi et livré avec chaque STF/12. FABARM est le seul fabricant à avoir défini un tel protocole de test ; la sécurité des clients est une priorité absolue !



FIRING TEST

PROVA A FUOCO
TEST EN TIR

25

EN Once the assembly phase of the STF/12 has been completed, with all its final components and accessories, the shotgun then undergoes a shooting test. This is the final quality control before the product is shipped. The objective here is to verify that the shotgun meets the specifications perfectly and that the various stages of

IT Terminata la fase di assemblaggio dell'STF/12 con tutti i suoi componenti ed accessori definitivi, il fucile viene sottoposto ad una prova a fuoco. Questo è il controllo di qualità finale prima della spedizione del prodotto. L'obiettivo è verificare che il fucile soddisfi perfettamente le specifiche e che le varie fasi della produzione di massa siano state tutte eseguite perfettamente. Il collaudatore qualità spara diverse cartucce delle marche leader sul mercato internazionale per controllare il caricamento e lo scaricamento dell'arma, la fluidità del riarmo, la velocità dell'alimentazione, la qualità d'espulsione e di percussione. Viene inoltre condotta un'attenta ispezione dell'arma per identificare anche il minimo difetto visivo. L'operatore provvederà in seguito a pulire accuratamente l'STF/12 e successivamente a lubrificarlo con un olio protettivo a lunga durata. Un cliente STF/12 ha quindi la garanzia di ricevere un'arma testata in fabbrica al 100%!

FR La phase de montage du STF/12 terminée, avec tous ses composants et accessoires définitifs, le fusil subit alors un test de fonctionnement en tir. Il s'agit de l'ultime contrôle qualité avant l'expédition du produit. L'objectif est ici de vérifier que le fusil réponde parfaitement au cahier des charges et que les différentes étapes de la production de masse aient toutes été parfaitement exécutées. Le contrôleur qualité procède au tir de plusieurs cartouches provenant des marques leader sur le marché International afin de vérifier le chargement et déchargement de l'arme, la fluidité du réarmement, la vitesse de l'alimentation, la qualité de l'éjection et de percussio. Une inspection minutieuse de l'arme est également conduite pour identifier même le plus léger défaut visuel. L'opérateur procèdera ensuite au nettoyage minutieux du STF/12 puis à son graissage avec une huile de protection longue-durée. Un client de STF/12 est ainsi assuré de recevoir une arme testée à 100 % en usine !

mass production have all been perfectly executed. The quality controller fires several cartridges from the leading brands of the international market, in order to check the loading and unloading of the weapon, the fluidity of the rearment, the velocity of the feeding, the quality of ejection and percussion. A close inspection of the

weapon is also conducted to identify even the slightest visual defect. The operator will then carefully clean the STF/12 and then lubricate it with a long-term protective oil. An STF/12 customer is thus guaranteed to receive a 100% factory tested weapon!

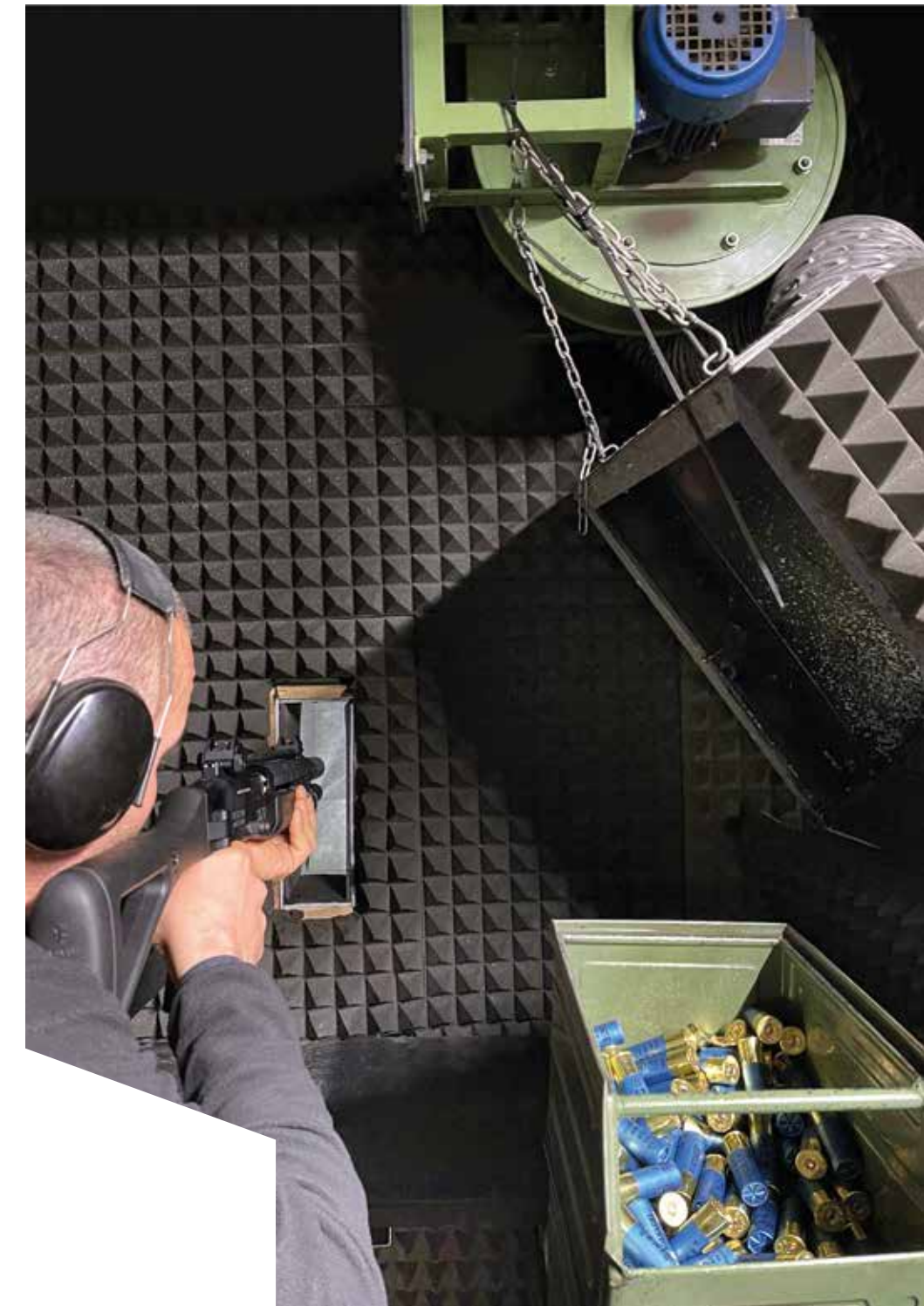

STF/12

SHORT

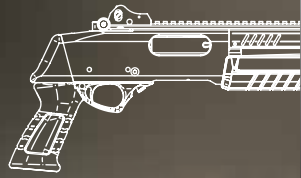

STF/12

COMPACT

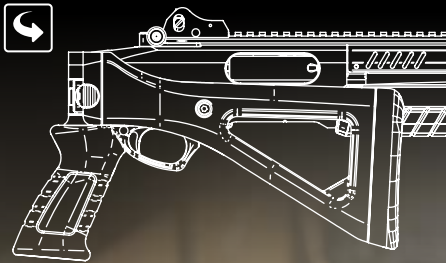

STF/12

TELESCOPIC

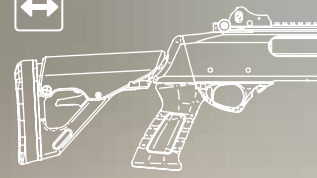

STF/12

PISTOLGRIP

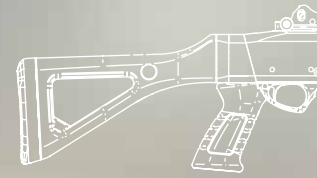

FABARM
PROFESSIONAL

STF/12

COMPACT

THE STF/12 COMPACT IS USING A POLYMER SIDE-FOLDING STOCK WHICH MAKE IT READILY ADAPTABLE AT THE OPERATOR LEVEL TO A MULTITUDE OF MISSIONS.

Il fucile SFT/12 COMPACT è dotato di un calcio pieghevole lateralmente che lo rende rapidamente adattabile alle necessità dell'operatore in una moltitudine di impieghi.

Le STF/12 COMPACT comporte une crosse pliable latéralement qui le rend aisément adaptable aux souhaits de l'opérateur pour une multitude de missions.



1530 STF/12 COMPACT 11"

1530 STF/12 COMPACT 11" NICKEL INITIAL

KEY FEATURES

EN Side folding composite stock provides a more compact package, can still be fired from the folded position.

IT Il calcio pieghevole lateralmente assicura un ingombro contenuto mantenendo la possibilità di sparare dalla posizione chiusa.

FR La crosse pliable latéralement permet d'obtenir une arme plus compacte elle maintient la possibilité de faire feu en position pliée.

EN The large "one-hand" quick release button allows the butt stock to instantly fold, even when wearing gloves.

IT L'ampio pulsante permette di chiudere il calcio istantaneamente, con una sola mano, anche in caso di guanti indossati.

FR Le large bouton poussoir permet de plier la crosse en un instant, avec une seule main et ce même en cas d'utilisation de gants.



1530 STF/12 COMPACT VIPER 11"





1630 STF/12 COMPACT F.E. 11" (ACCESSORIES NOT INCLUDED)



1630 STF/12 COMPACT 14" (ACCESSORIES NOT INCLUDED)

OPTIONAL:
MIL-STD 1913 RAIL
Product No: B-149-A



	STF/12 COMPACT	STF/12 COMPACT INITIAL	
GAUGE	12 / 76 mm (12-3")	12 / 76 mm (12-3")	
BARREL LENGTHS	11"/28 cm - 14"/36cm - 18"/46 cm 20"/51 cm - 22"/56cm	11"/28 cm - 14"/36cm - 18"/46 cm 20"/51 cm - 22"/56cm	
BORE PROFILE	11"/28 cm - 14"/36cm - 18"/46 cm : 18.4 mm 20"/51 cm - 22"/56cm : TRIBORE HP	11"/28 cm - 14"/36cm - 18"/46 cm : 18.4 mm 20"/51 cm - 22"/56cm : TRIBORE HP	
CHOKE TUBES INCLUDED	Inner HP accuracy	Inner HP accuracy	
TOTAL CAPACITY	11" / 28 cm : 5+1 14" / 36 cm : 5+1 18" / 46 cm : 6+1	20" / 51 cm : 7+1	11" / 28 cm : 4+1 14" / 36 cm : 5+1 18" / 46 cm : 6+1
COOLING JACKET	Yes	Yes	
STOCK	Folding	Folding	
LENGTH OF PULL	12,6" / 320 mm	12,6" / 320 mm	
GRIP AND FOREND FINISHING	Soft touch	Soft touch	
FRAME	Ergal 55	Ergal 55	
FRAME FINISHING	Black non glare or Cerakote flat earth or (F.E.) or Nickel coated or Cerakote olive drab green (O.D.G)	Black non glare or Cerakote flat earth or (F.E.) or Nickel coated or Cerakote olive drab green (O.D.G)	
SIGHTS	Detachable ghost and front sights	Open sights, low profile	
TRIGGER SYSTEM	Racing	Racing	
DOOR BREACHER	Yes	No	
PICATINNY MIL-STD 1913	Yes	No	
PICATINNY RAIL UNDER FOREND	Yes	Yes	
WEIGHT (WITH 11" BARREL)	3.750 Kg	3,310 Kg	
SLING SWIVEL PLATE	At 9 O' clock	At 9 O' clock	
PROOF TEST	1630 Bar	1630 Bar	
PACKAGING	Carton box	Carton box	
OPTIONAL	Mil-std 1913 rail assembled on forend sides	Mil-std 1913 rail assembled on forend sides	

According to Italian legislation, all the STF models are defined as **firearms**, pursuant to art. 2 Law no. 110/1975 and the subsequent law n° 135/2012 whose classification numbers, available on the website www.fabarm.com, correspond to categories referred to in Annex I of the European Directive (EU) 2021/555.

STF/12

SHORT

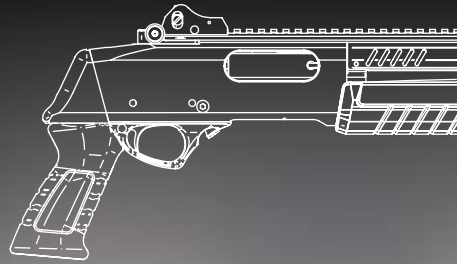

STF/12

COMPACT

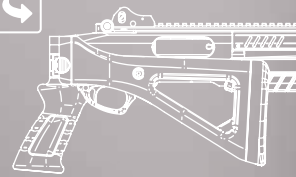

STF/12

TELESCOPIC

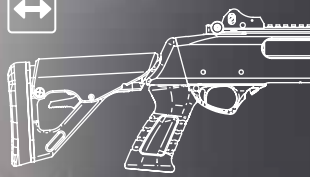

STF/12

PISTOLGRIP

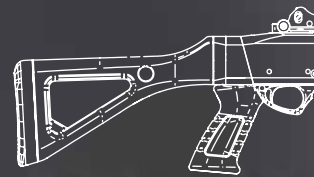

FABARM
PROFESSIONAL

STF/12

SHORT

THE STF/12 SHORT IS ASSEMBLED WITH A COMPOSITE GRIP, PERFECT WHEN ENGAGEMENT RANGES ARE SHORT.

Il fucile STF/12 SHORT è dotato di impugnatura in materiale composito, perfetto dove le distanze di ingaggio sono ravvicinate.

Le STF/12 SHORT possède une poignée en composite, parfait quand l'espace d'intervention est réduit.



 STF/12 SHORT 11"



 STF/12 SHORT VIPER 11"



KEY FEATURES

EN Combining the power and capabilities of a pump shotgun with the size of a pistol, with an overall length just under 21 inches (11" barrel initial).

IT Combinare la potenza e la versatilità di un fucile a pompa con l'ingombro di una pistola avendo una lunghezza totale di soli 53 cm (canna 28 cm INITIAL).

FR Combiner la puissance et les capacités d'un fusil à pompe avec la taille d'un pistolet, avec une longueur hors-tout ne dépassant pas 53 cm (canon 28 cm INITIAL).



OPTIONAL:
MIL-STD 1913 RAIL
Product No: B-149-A



1630 STF/12 SHORT F.E. 11"



1630 STF/12 SHORT 11" NICHEL INITIAL



1 point tactical sling
Product No: E-622



	STF/12 SHORT	STF/12 SHORT INITIAL
GAUGE	12 / 76 mm (12-3")	12 / 76 mm (12-3")
BARREL LENGTHS	11"/28 cm - 14"/36cm - 18"/46 cm 20"/51 cm - 22"/56cm	11"/28 cm - 14"/36cm - 18"/46 cm 20"/51 cm - 22"/56cm
BORE PROFILE	11"/28 cm - 14"/36cm - 18"/46 cm : 18.4 mm 20"/51 cm - 22"/56cm : TRIBORE HP	11"/28 cm - 14"/36cm - 18"/46 cm : 18.4 mm 20"/51 cm - 22"/56cm : TRIBORE HP
CHOKE TUBES INCLUDED	Inner HP accuracy	Inner HP accuracy
TOTAL CAPACITY	11" / 28 cm : 5+1 14" / 36 cm : 5+1 18" / 46 cm : 6+1	11" / 28 cm : 4+1 14" / 36 cm : 5+1 18" / 46 cm : 6+1
COOLING JACKET	Yes	Yes
STOCK	Grip	Folding
GRIP AND FOREND FINISHING	Soft touch	Soft touch
FRAME	Ergal 55	Ergal 55
FRAME FINISHING	Black non glare or Cerakote flat earth or (F.E.) or Nickel coated or Cerakote olive drab green (O.D.G)	Black non glare or Cerakote flat earth or (F.E.) or Nickel coated or Cerakote olive drab green (O.D.G)
SIGHTS	Detachable ghost and front sights	Open sights, low profile
TRIGGER SYSTEM	Racing	Racing
DOOR BREACHER	Yes	No
PICATINNY MIL-STD 1913	Yes	No
PICATINNY RAIL UNDER FOREND	Yes	Yes
WEIGHT (WITH 11" BARREL)	3,110 Kg	2,670 Kg
SLING SWIVEL PLATE	At 12 O' clock	At 9 O' clock
PROOF TEST	1630 Bar	1630 Bar
PACKAGING	Carton box	Carton box
OPTIONAL	Mil-std 1913 rail assembled on forend sides	Mil-std 1913 rail assembled on forend sides

According to Italian legislation, all the STF models are defined as **firearms**, pursuant to art. 2 Law no. 110/1975 and the subsequent law n° 135/2012 whose classification numbers, available on the website www.fabarm.com, correspond to categories referred to in Annex I of the European Directive (EU) 2021/555.

STF/12

SHORT

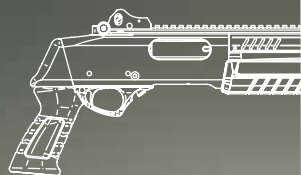

STF/12

COMPACT

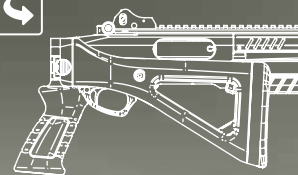

STF/12

TELESCOPIC

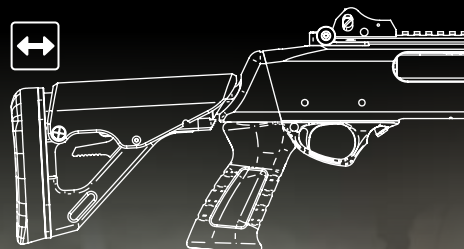

STF/12

PISTOLGRIP

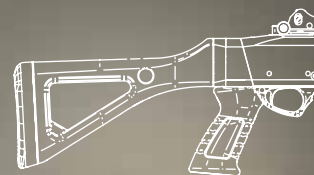
FABARM
 PROFESSIONAL

STF/12

TELESCOPIC

THE TELESCOPIC STOCK FEATURES AN ADJUSTABLE CHEEK REST WITH 5 DROP POSITIONS THAT REMAINS IN PLACE INDEPENDENT FROM THE LENGTH-OF-PULL POSITION. A "ONE-HAND" BUTTON ALLOWS TO INSTANTLY ADJUST ITS DROP FOR USING IDEALLY THE STF/12 WITH ALL TYPES AND SIZES OF SCOPES.

Il calcio telescopico prevede un nasello, regolabile su 5 posizioni di altezza, che rimane nella configurazione selezionata indipendentemente dalla lunghezza scelta per il calcio. Un bottone azionabile con una sola mano permette di regolare velocemente la sua piega per un utilizzo perfetto dell'STF/12 con tutti i tipi e dimensioni di ottica.

La crosse Télescopique possède un busc réglable avec 5 positions de hauteur, lequel reste en place indépendamment de la longueur de crosse choisie. Un bouton actionnable avec une seule main permet de régler instantanément sa pente pour utiliser idéalement l'STF/12 avec tous les types et toutes les tailles de lunettes de tir.



STF/12 TELESCOPIC 11"
(ACCESSORIES NOT INCLUDED)



KEY FEATURES

EN A telescopic stock with 6 optional length positions to perfectly fit a variety of operator body, body armor and vehicle deployments.

IT Un calcio telescopico regolabile su 6 posizioni di lunghezza per adattarsi perfettamente alla taglia dell'operatore, alle protezioni indossate o nel caso di impiego su veicoli.

FR Une crosse rétractable qui comporte une longueur réglable à 6 différentes positions pour s'adapter parfaitement à la taille des opérateurs, la taille des gilets de protection ou dans le cas d'utilisation avec véhicules.



STF/12 TELESCOPIC 14"



STF/12 TELESCOPIC 14"
(ACCESSORIES NOT INCLUDED)



STF/12 TELESCOPIC 18"

OPTIONAL:
MIL-STD 1913 RAIL
Product No: B-149-A





1630 STF/12
TELESCOPIC F.E. 11"
(ACCESSORIES
NOT INCLUDED)



1630 STF/12
TELESCOPIC F.E. 11"
(ACCESSORIES NOT
INCLUDED)



1630 STF/12
TELESCOPIC 20"
(ACCESSORIES NOT
INCLUDED)



	STF/12 TELESCOPIC	STF/12 TELESCOPIC INITIAL	
GAUGE	12 / 76 mm (12-3")	12 / 76 mm (12-3")	
BARREL LENGTHS	11"/28 cm - 14"/36cm - 18"/46 cm 20"/51 cm - 22"/56cm	11"/28 cm - 14"/36cm - 18"/46 cm 20"/51 cm - 22"/56cm	
BORE PROFILE	11"/28 cm - 14"/36cm - 18"/46 cm : 18.4 mm 20"/51 cm - 22"/56cm : TRIBORE HP	11"/28 cm - 14"/36cm - 18"/46 cm : 18.4 mm 20"/51 cm - 22"/56cm : TRIBORE HP	
CHOKE TUBES INCLUDED	Inner HP accuracy	Inner HP accuracy	
TOTAL CAPACITY	11" / 28 cm : 5+1 20" / 51 cm : 7+1 14" / 36 cm : 5+1 22" / 56 cm : 7+1 18" / 46 cm : 6+1	11" / 28 cm : 4+1	20" / 51 cm : 7+1
COOLING JACKET	Yes	Yes	
STOCK	Telescopic	Telescopic	
GRIP AND FOREND FINISHING	Soft touch	Soft touch	
FRAME	Ergal 55	Ergal 55	
FRAME FINISHING	Black non glare or Cerakote flat earth (F.E) or Nickel coated	Black non glare or Cerakote flat earth (F.E) or Nickel coated	
SIGHTS	Detachable ghost and front sights	Open sights, low profile	
TRIGGER SYSTEM	Racing	Racing	
DOOR BREACHER	Yes	No	
PICATINNY MIL-STD 1913	Yes	No	
PICATINNY RAIL UNDER FOREND	Yes	Yes	
WEIGHT (WITH 11" BARREL)	3,900 Kg	3,460 Kg	
SLING SWIVEL PLATE	At 9 O' clock	At 9 O' clock	
PROOF TEST	1630 Bar	1630 Bar	
PACKAGING	Carton box	Carton box	
OPTIONAL	Mil-std 1913 rail assembled on forend sides	Mil-std 1913 rail assembled on forend sides	

STF/12

SHORT

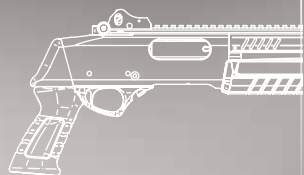

STF/12

COMPACT

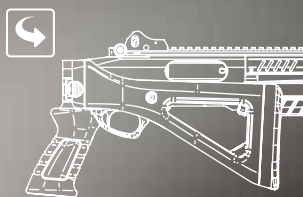

STF/12

TELESCOPIC

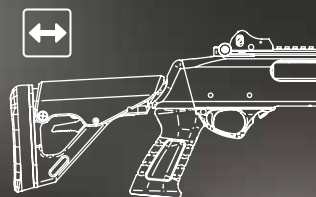

STF/12

PISTOLGRIP

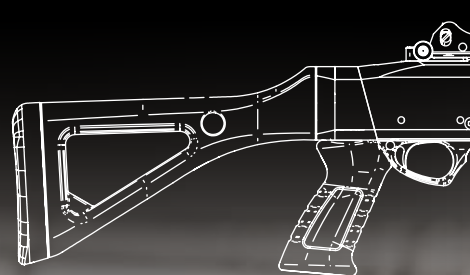
FABARM
 PROFESSIONAL

STF/12

PISTOLGRIP

THE STF/12 PISTOLGRIP IS FEATURED A PREMIUM ERGONOMIC FIXED STOCK WITH TEXTURED GRIPPING SURFACES AND A PARALLEL COMB TO KEEP THE SHOTGUN ON THE TARGET WHEN FIRING.

STF/12 PISTOLGRIP è fornito di un calcio fisso ergonomico con superfici grippanti ed una impostazione per ridurre il rilevamento durante il tiro.

Le STF/12 PISTOLGRIP possède une crosse fixe très ergonomique qui a des zones rugueuses pour une parfaite prise en main et un busc dont la pente, parallèle au canon, réduit le relèvement du fusil lors de tirs.



1630 STF/12 PISTOLGRIP 20"

1630 STF/12 PISTOLGRIP 18"

KEY FEATURES

EN Ergonomic, comfortable with its premium HRA recoil pad, this fixed stock delivers impressive precision shots after shots with a handy package.

IT Ergonomic, confortevole grazie al calciolo HRA, questo calcio fisso permette una precisione sorprendente colpo dopo colpo, il tutto in una configurazione estremamente maneggevole.

FR Ergonomique, confortable avec son sabot amortisseur HRA de haute qualité, cette crosse fixe permet une précision impressionnante tirs après tirs, le tout avec une parfaite maniabilité.



OPTIONAL:
MIL-STD 1913 RAIL
Product No: B-149-A

1630 STF/12 PISTOLGRIP 20"
(ACCESSORIES NOT INCLUDED)



1630 STF/12 PISTOLGRIP F.E. 20"



1630 STF/12 PISTOLGRIP 20" (ACCESSORIES NOT INCLUDED)



1630 STF/12 PISTOLGRIP 18"



	STF/12 PISTOLGRIP	STF/12 PISTOLGRIP INITIAL
GAUGE	12 / 76 mm (12-3")	12 / 76 mm (12-3")
BARREL LENGTHS	11"/28 cm - 14"/36cm - 18"/46 cm 20"/51 cm - 22"/56cm	11"/28 cm - 14"/36cm - 18"/46 cm 20"/51 cm - 22"/56cm
BORE PROFILE	11"/28 cm - 14"/36cm - 18"/46 cm : 18.4 mm 20"/51 cm - 22"/56cm : TRIBORE HP	11"/28 cm - 14"/36cm - 18"/46 cm : 18.4 mm 20"/51 cm - 22"/56cm : TRIBORE HP
CHOKE TUBES INCLUDED	Inner HP accuracy	Inner HP accuracy
TOTAL CAPACITY	11" / 28 cm : 5+1 14" / 36 cm : 5+1 18" / 46 cm : 6+1	11" / 28 cm : 4+1 20" / 51 cm : 7+1 14" / 36 cm : 5+1 22" / 56 cm : 7+1
COOLING JACKET	Yes	Yes
STOCK	Fixed	Fixed
GRIP AND FOREND FINISHING	Soft touch	Soft touch
FRAME	Ergal 55	Ergal 55
FRAME FINISHING	Black non glare or Cerakote flat earth or (F.E) or Nickel coated	Black non glare or Cerakote flat earth or (F.E) or Nickel coated
SIGHTS	Detachable ghost and front sights	Open sights, low profile
TRIGGER SYSTEM	Racing	Racing
DOOR BREACHER	Yes	No
PICATINNY MIL-STD 1913	Yes	No
PICATINNY RAIL UNDER FOREND	Yes	Yes
WEIGHT (WITH 11" BARREL)	3,770 Kg	3,330 Kg
SLING SWIVEL PLATE	At 9 O' clock	At 9 O' clock
PROOF TEST	1630 Bar	1630 Bar
PACKAGING	Carton box	Carton box
OPTIONAL	Mil-std 1913 rail assembled on forend sides	Mil-std 1913 rail assembled on forend sides

According to Italian legislation, all the STF models are defined as **firearms**, pursuant to art. 2 Law no. 110/1975 and the subsequent law n° 135/2012 whose classification numbers, available on the website www.fabarm.com, correspond to categories referred to in Annex I of the European Directive (EU) 2021/555.



ACCESSORIES

ACCESSORI
ACCESSOIRES



WATERPROOF HARD CASE

Product No: E-639

EN Made of Copolymer Polypropylene compound, this case is waterproof resistant, resistant to humidity, dust, to temperatures from - 33° C to + 90° C (- 91° F to + 194° F) and almost unbreakable. Its construction has large front and side handles, a pressure purge valve and transport wheels for easier handling. It is 100 % made in Italy and reaches the highest military standard qualifications.

IT Il corpo valigia in resina plastica Copolymer polipropilene è a tenuta stagna ed è caratterizzato da un'eccezionale resistenza agli urti, alle sostanze corrosive, all'acqua, alle temperature da - 33° C a + 90° C (- 91° F a + 194° F); praticamente indistruttibile. E' dotata di maniglie laterali e frontali, una valvola di pressurizzazione e delle ruote per renderne agevole il trasporto. Costruzione 100 % made in Italy e certificata secondo alti standard militari.

FR Réalisée en polymère de Polypropylène, cette valise est résistante à l'eau, à la poussière, aux températures de - 33° C à + 90° C (- 91° F à + 194° F) et pratiquement incassable. Elle possède de larges poignées frontales et latérales, une valve de pressurisation et des roulettes pour un transport facile. Elle est produite 100 % en Italie et certifiée selon les plus hauts standards militaires de qualité.

SOFT TACTICAL BAG

Product No: E-621



EN A quick, convenient, and highly functional storage solution for your STF/12 shotgun. Made in strong 600 D polyester, it has reinforced handles and two compartments with equipped with straps; an integrated padded divider prevents your shotgun or accessories from dings and scratches. Dimensions mm. 860 x 260 (33,85 " x 10,2").

IT Una soluzione rapida, adeguata e perfettamente funzionale alla protezione del vostro fucile STF/12. Confezionata in Poliestere 600 D molto resistente, ha maniglie rinforzate e due scomparti con fasce in velcro. Una divisoria imbottita evita il contatto tra il fucile e tutti i suoi accessori. Dimensioni mm: 860 x 260 (33,85 " x 10,2").

FR Une solution rapide, adaptée et parfaitement fonctionnelle pour protéger votre fusil STF/12. Réalisé en Polyester 600 Deniers très robuste, il a des poignées renforcées et deux compartiments équipés de brides avec velcro. Un diviseur rembourré protège votre fusil et ses accessoires de chocs entre eux. Dimensions : 860 mm x 260 mm (33,85 " x 10,2").

ACCESSORIES

ACCESSORI
ACCESSOIRES



COMMANDO SOFT BAG

Product No: E-638

EN Designed for your STF/12 shotgun, this commando bag provides a professional use protection. A premium 600 D polyester outer shell repels ideally moisture and shocks. Adjustable shoulder straps can be converted to backpack carry mode in seconds. Dimensions mm. 900 x 260 (35,4" x 10,2") with two main compartments.

IT Sviluppata specificatamente per il vostro fucile STF/12, questa borsa Commando offre protezione nel caso di utilizzo professionale. Il tessuto esterno in poliestere 600 D di alta qualità protegge efficacemente dall'umidità e dagli urti. Le bretelle regolabili consentono di trasformarla in zaino in un attimo. Dimensioni mm. 900 x 260 (35,4" x 10,2") con due scomparti principali.

FR Développé spécialement pour votre fusil STF/12, ce sac commando offre une protection dans le cadre d'usages professionnels. Le tissu extérieur en polyester 600 Deniers de haute qualité protège idéalement de l'humidité et des chocs. Des bretelles ajustables permettent de le convertir en port de type sac à dos en une seconde. Dimensions 900 mm x 260 mm (35,4" x 10,2") avec deux compartiments principaux.

**1 POINT
TACTICAL
SLING
WITH HOOK**

Product No: E-622

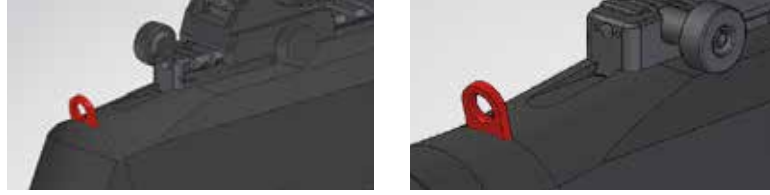

3 POINT TACTICAL SLING

Product No: E-624



1 POINT TACTICAL SLING

Product No: E-623





ACCESSORIES

ACCESSORI
ACCESSOIRES



**SHELLS HOLDER
4 ROUNDS**

Product No: B-204-A

- EN Compatible with sling swivel on 9 o'clock position.
- IT Compatibile con porta-cinghia a ore 9 (laterale)
- FR Compatible avec support bretelle en position 9 heures (laterale)



**SHELLS HOLDER
5 ROUNDS**

Product No: B-200-A

- EN Compatible with sling swivel on 12 o'clock position.
- IT Compatibile con porta-cinghia a ore 12 (superiore)
- FR Compatible avec support bretelle en position 12 heures (supérieure)



**SLING SVIVEL
PLATE**

**9 O'CLOCK
POSITION**
Product No:
A-147

**12 O'CLOCK
POSITION**
Product No:
A-148



MIL-STD 1913 RAIL

Product No: B-149-A
mm. 54 long (2,12")

Compatible with STF/12
produced after 01/01/2016



**SIGNATURE CAP**

Product No: E-637

- EN** Fabric: 100 % cotton.
Colours: Black and silver with front side and back side logo embroideries.
Unique size.
- IT** Tessuto: 100 % cotone.
Colori: Nero e grigio argento con logo ricamato su fronte e retro.
Taglia unica.
- FR** 100 % coton.
Couleurs : Noire et gris argent avec logos brodés sur le devant et l'arrière.
Taille unique.

**OVERALL
LENGTH IN CM****LUNGHEZZA TOTALE IN CM
LONGUEUR TOTALE EN CM**

	11"BARREL 28 cm BARREL	14"BARREL 28 cm BARREL	18"BARREL 46 cm BARREL	20"BARREL 51 cm BARREL	22"BARREL 56 cm BARREL
STF/12 SHORT	53	60,6	70,8	75,9	80,95
STF/12 COMPACT (FOLDED STOCK)	53	60,6	70,8	75,9	80,95
STF/12 COMPACT (EXTENDED STOCK)	75	82,6	92,8	97,9	102,95
STF/12 TELESCOPIC (COLLAPSED STOCK)	68	75,6	85,8	90,9	95,95
STF/12 TELESCOPIC (EXTENDED STOCK)	79	86,6	96,8	101,9	106,95
STF/12 PISTOLGRIP	75	82,6	92,8	97,9	102,95

For shotguns with muzzle break, please add 9 cm
Per fucili con muzzle break, aggiungere cm 9
Pour fusils avec muzzle break, merci d'ajouter 9 cm

NB : 1 INCH = 2,54 cm

**EDITOR IN CHARGE:
FABARM S.P.A.**

Graphic: www.agenziap.it
All efforts have been made to ensure that all product photographs, descriptions and specifications in this catalogue are accurate. However inadvertent errors may occur. FABARM reserves the right to modify or change specifications without notice.



FABARM
PROFESSIONAL

MADE IN ITALY

STF/12



FABARM
PROFESSIONAL

FABARM S.p.A.

Via Averolda, 31 - 25039 TRAVAGLIATO (BS) - ITALY
www.fabarm.com

FABARM PROFESSIONAL
is a division of FABARM S.p.A